

Quick Start Guide

SpeedFace-V3L

Version: 1.4

Overview

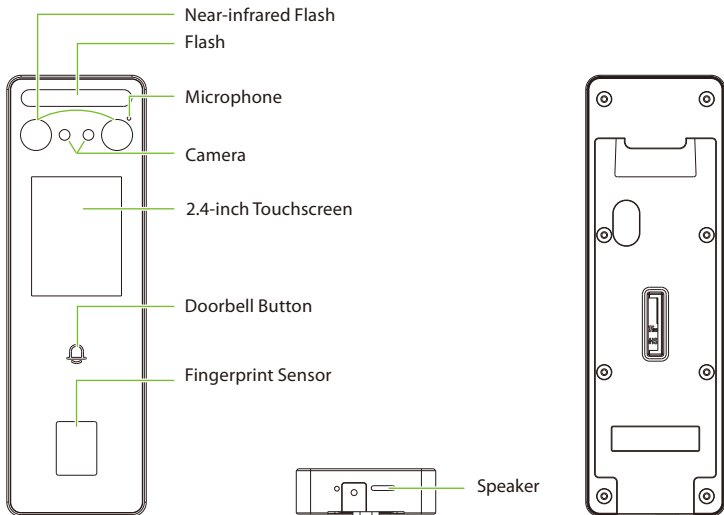

Terminal Block

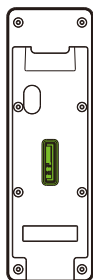

— BELL+	—	<i>Bell & Alarm</i>
— BELL-	—	
— ALARM+	—	
— ALARM-	—	

— NC	—	<i>Lock, Door Sensor, Exit Button & Auxiliary Input</i>
— COM	—	
— NO	—	
— SEN	—	
— GND	—	
— BUT	—	
— AUX	—	

— WDO-OUT	—	<i>Wiegand</i>
— WD1-OUT	—	
— INWD0	—	
— INWD1	—	
— GND	—	

— 485A	—	<i>RS485</i>
— 485B	—	
— GND	—	



Power In



Network

Installation Environment

Please refer to the following recommendations for installation.



KEEP DISTANCE



AVOID GLASS
REFRACTION



AVOID DIRECT
SUNLIGHT
AND EXPOSURE



KEEP EFFECTIVE
DISTANCE
0.3-1.2m

Device Installation

- ① Attach the mounting template sticker to the wall, and drill holes according to the mounting paper.
- ② Fix the backplate on the wall using wall mounting screws.
- ③ Attach the device to the backplate.
- ④ Fasten the device to the backplate with a security screw.

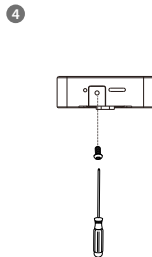
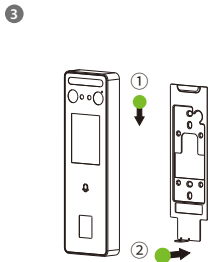
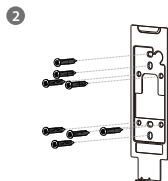
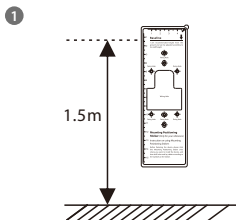

Standalone Installation

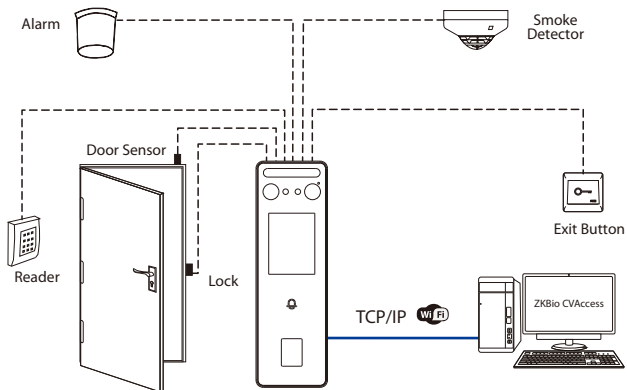

Power Connection

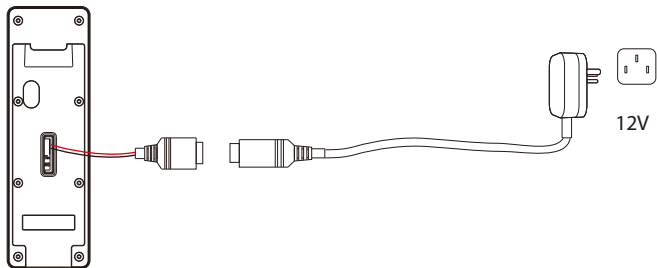

Recommended AC Adapter

- 1) 12V \pm 10%, at least 1500mA.
- 2) To share the power with other devices, use an AC Adapter with higher current ratings.

Ethernet Connection

Connect the device and computer software over an Ethernet cable. As shown in the example below:

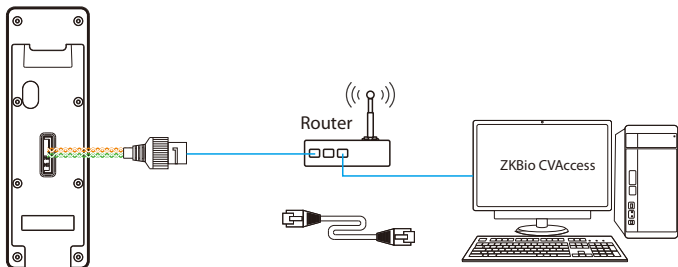

Default IP address: 192.168.1.201
Subnet mask: 255.255.255.0

IP address: 192.168.1.130
Subnet mask: 255.255.255.0

Click on [COMM.] > [Ethernet] to set the relevant parameters of network.

Note: In LAN, the IP addresses of the server (PC) and the device must be in the same network segment when connecting to the **ZKBio CVAccess** software.

Wiegand Connection

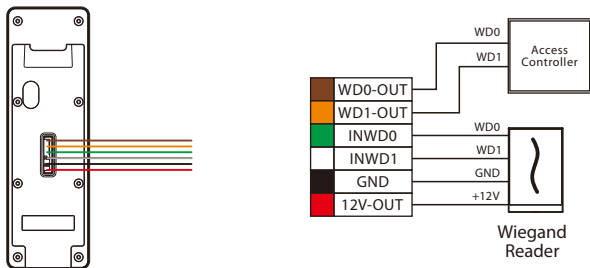

RS485 Connection

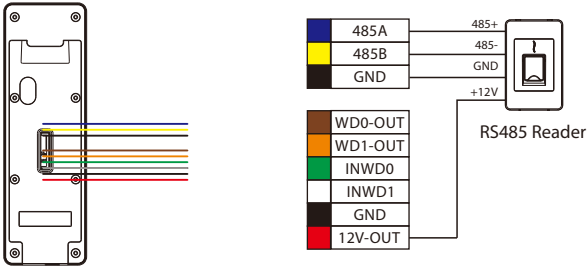

Note: 485A and 485B can be connected to the Barrier gate or the RS485 Reader, separately, but cannot be connected to the gate and reader at the same time.

Door Sensor, Exit Button, Alarm & Auxiliary Connection

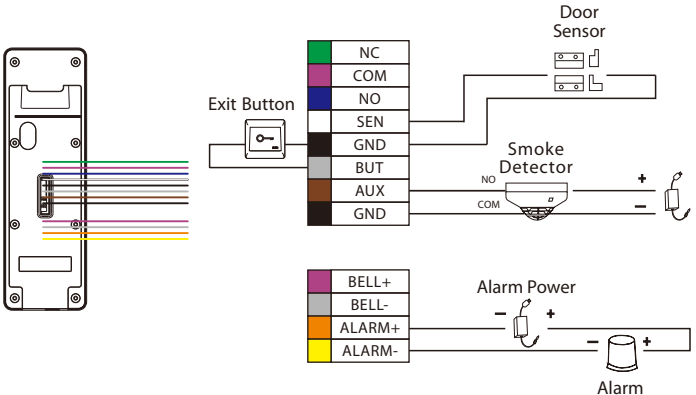

Lock Relay Connection

The system supports **Normally Opened Lock** and **Normally Closed Lock**. The **NO LOCK** (normally unlocked when power-on) is connected with 'NO' and 'COM' terminals, and the **NC LOCK** (normally locked when power-on) is connected with 'NC' and 'COM' terminals. Take NC Lock as an example below:

1) Device not sharing power with the lock

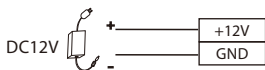

 Do not reverse the polarity.

Normally Closed Lock

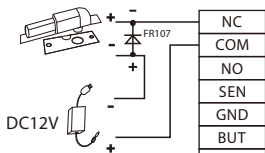

 Maximum 30V 3A input.

2) Device sharing power with the lock

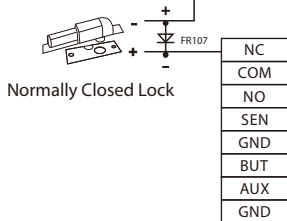

User Registration

When there is no super administrator set in the device, click on  to enter the menu. Add a new user and set User Role to Super Admin, then the system requests for the administrator's verification before entering the menu. It is recommended to register a super administrator initially for security purposes.

Method 1: Registering on the Device

Click on  > [User Mgt.] > [New User] to register a new user. The options include entering the user ID and Name, setting User Role and Access Control Role, registering Fingerprint, Face, Card Number and Password.

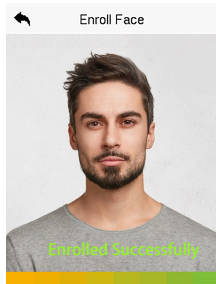
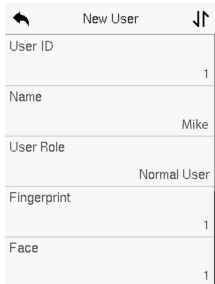
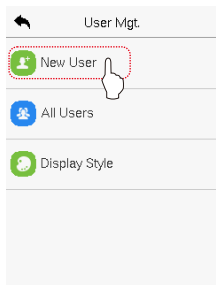
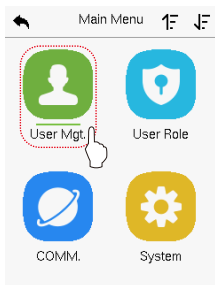
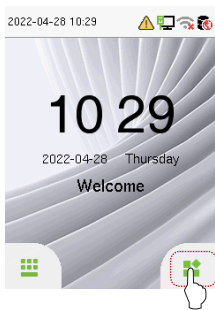

Method 2: Register on ZKBio CVAccess Software

Please set the IP address and cloud service server address in the Comm. Menu option on the device.

1. Click **[Access]** > **[Device]** > **[Search]** > **[Search]** to search the device on the software. When an appropriate server address and port is set on the device, the searched devices are displayed automatically.

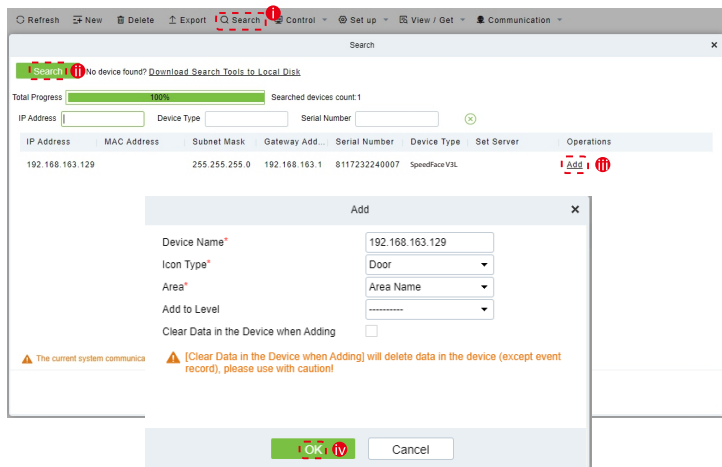

2. Click **[Add]** in operation column, a new window will pop-up. Select Icon type, Area, and Add to Level from each dropdowns and click **[OK]** to add the device.
3. Click **[Personnel]** > **[Person]** > **[New]** and fill in all the required fields to register a new users in the software.
4. Click **[Attendance]** > **[Attendance Device]** > **[Device Control]** > **[Synchronize Software Data to the Device]** to synchronize all the data to the device including the new users.

For more details, please refer to the *ZKBio CVAccess User Manual*.

Method 3: Register on the Phone

Once the ZKBio CVAccess software is installed, the users could enroll their face via a browser application on their own mobile phone.

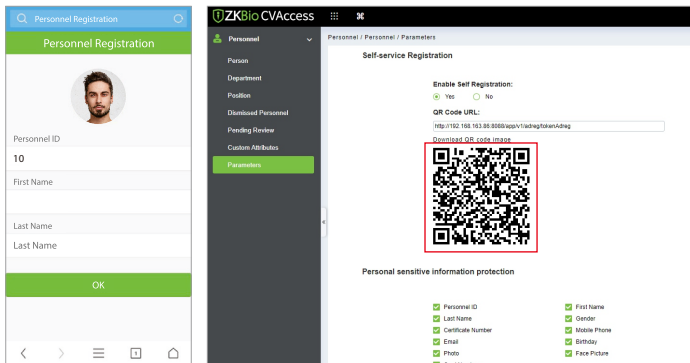

1. Click **[Personnel]** > **[Parameters]**, input “http://Server address: Port” in the QR Code UGL bar. The software will automatically generate a QR code. Scan the QR code or login onto “http://Server address: Port/app/v1/adreg” by the mobile phone to register users.



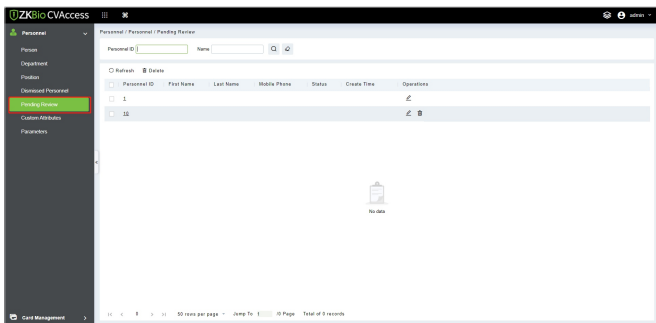

2. The users will be displayed in **[Personnel]** > **[Pending Review]**.



Ethernet and Cloud Server Settings

Click on  > [COMM.] > [Ethernet] to set the network parameters. If the TCP/IP communication of the device is successful, the icon  will be displayed in the upper right corner of the standby interface.

Click on  > [COMM.] > [Cloud Server Setting] to set the server address and server port, that is, the IP address and port number of the server after the software is installed. If the device communicates with the server successfully, the icon  will be displayed in the upper right corner of the standby interface.

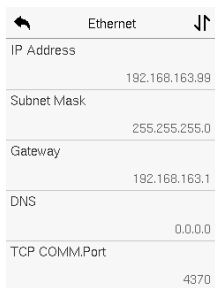
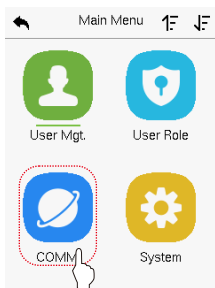

Ethernet	
IP Address	192.168.163.99
Subnet Mask	255.255.255.0
Gateway	192.168.163.1
DNS	0.0.0.0
TCP COMM.Port	4370

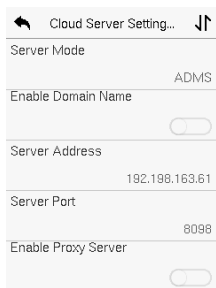

Cloud Server Setting...	
Server Mode	ADMS
Enable Domain Name	<input type="checkbox"/>
Server Address	192.198.163.61
Server Port	8098
Enable Proxy Server	<input type="checkbox"/>

Note:

While pairing the device with ZKBio CVAccess software. Make sure that the option **Enable Domain Name** is disabled and the correct server address and port are entered.

Server Address: Set as the IP address of the ZKBio CVAccess server.

Server Port: Set as the service port of ZKBio CVAccess.

Access Control Setting

Click on  > [Access Control] to enter the access control management interface and set relevant parameters of access control.

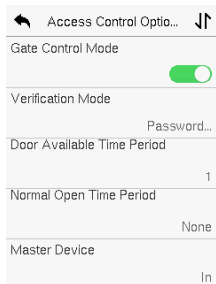
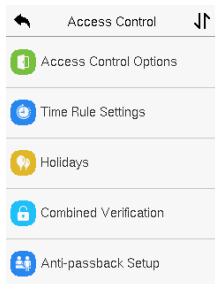
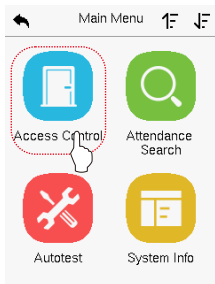

Attendance Record

Click on  > [Attendance Search] to enter the record query interface, input the user ID and select the time range, the corresponding attendance record will be displayed.

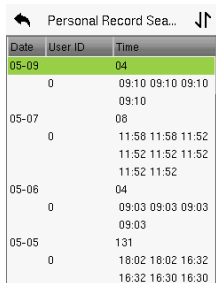
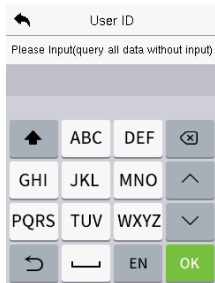
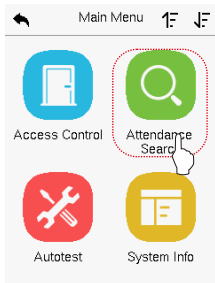

Personal Record Sea...

Date	User ID	Time
05-09	04	
	0	09:10 09:10 09:10
		09:10
05-07		08
	0	11:58 11:58 11:52
		11:52 11:52 11:52
		11:52 11:52
05-06		04
	0	09:03 09:03 09:03
		09:03
05-05		131
	0	18:02 18:02 16:32
		16:32 16:30 16:30

System Setting

Click on  > [System] to enter the system interface to set the related system parameters for optimizing the accessibility of the device.

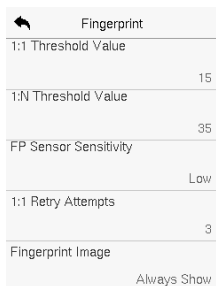
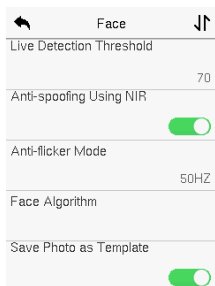
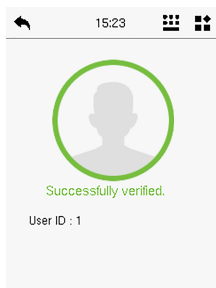
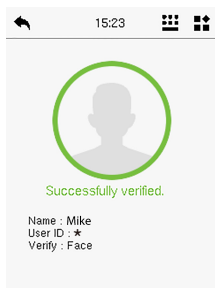
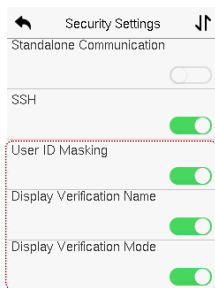
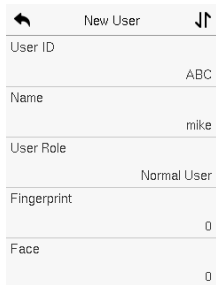
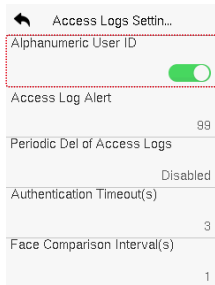
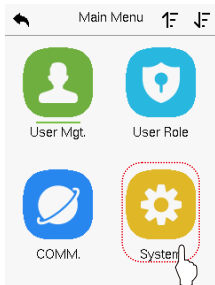

ZKTeco Industrial Park, No. 32, Industrial Road,
Tangxia Town, Dongguan, China.

Phone : +86 769 - 82109991

Fax : +86 755 - 89602394

www.zkteco.com

